

# North America Installation Guide for Lunawood Facade





# Contents

<b>00</b>	<b>How to use this guide</b>	<b>4</b>
<b>01</b>	<b>Facades don't age in the same way</b>	<b>6</b>
01.1.	Examining the site	7
01.2.	Select cladding orientation	9
01.3.	Choose the type of profile	10
<b>02</b>	<b>Choose support battens and fixing system</b>	<b>12</b>
02.1.	Functions of the air cavity behind cladding	13
02.2.	Choose the material for the support battens	13
02.3.	Facade with timber support battens	14
02.4.	Facade with metal support battens	15
02.5.	Choose the fixing system	16
<b>03</b>	<b>Installation instructions by system</b>	<b>18</b>
03.1.	Vertical   Tongue & groove   Timber support battens	19
03.2.	Vertical   Tongue & groove   Metal support battens	20
03.3.	Vertical   Battens   Timber support battens   Visible fixing	21
03.4.	Vertical   Battens   Timber support battens   Hidden fixing	22
03.5.	Vertical   Battens   Metal support battens   Visible fixing	23
03.6.	Vertical   Battens   Metal support battens   Hidden fixing	24
03.7.	Horizontal   Tongue & groove   Timber support battens	25
03.8.	Horizontal   Tongue & groove   Metal support battens	26
03.9.	Horizontal   Battens   Timber support battens   Visible fixing	27
03.10.	Horizontal   Battens   Timber support battens   Hidden fixing	28
03.11.	Horizontal   Battens   Metal support battens   Visible fixing	29
03.12.	Horizontal   Battens   Metal support battens   Hidden fixing	30
03.13.	Construction details   Top and bottom edges	31
03.14.	Construction details   Insect mesh	32
03.15.	Construction details   Windows openings	33
<b>04</b>	<b>Tips for designing and installing a Lunawood facade</b>	<b>34</b>
04.0.	Using side of Lunawood Thermowood	35
04.1.	Fix Lunawood facade profiles correctly	36
04.2.	Check the distance between ground and cladding	37
04.3.	Ensure adequate ventilation of the air cavity behind cladding	37
04.4.	Protect the support wall	38
04.5.	Install insect mesh	38
04.6.	Avoid moisture traps	38
04.7.	Pay attention to key points	39
04.8.	Use breathable protection coatings	39
04.9.	Consider weathering process during the design	40
04.10.	Three strategies to achieve the desired finish	41
<b>05</b>	<b>Materials handling and storage</b>	<b>44</b>
05.1.	How to storage timber on the construction site	45
05.2.	Handle with care	45
<b>06</b>	<b>Tools and equipment needed</b>	<b>46</b>
06.1.	Materials	47
06.2.	Tools	47
06.3.	Personal Protective Equipment (PPE)	47
06.4.	Tips for working with Lunawood Thermowood	47

---

# How to use this guide

This guide is based on premium properties of Lunawood ThermoWood® and wood construction best practices and research. The guide is suitable for use as an indicative guide for facade products within the Lunawood Collection. See also product specific installation guides for Lunawood Collection products [www.lunawood.com/us/download-centre](http://www.lunawood.com/us/download-centre).

Local building regulations and instructions must be followed and local circumstances observed. Always contact your own local Lunawood supplier for comprehensive and up-to-date information.

---

## 01



### Facades don't age in the same way

Study the project **location**: sun exposure, orientation, rainfall. These are key factors in the performance of timber facades.

Horizontal, vertical, diagonal?

Select **the most suitable orientation** for the cladding based on the local climate and the aesthetics of the project.

Choose the most **suitable type of Lunawood profile** for the facade.

---

## 02



### Choose support battens and fixing system

Choose the **material for the support battens** on which timber cladding will be fixed.

Review the recommended installation guidelines for the batten material chosen and cladding orientation.

Select the fixings for connecting the support battens to the backing wall.

---

## 03



### Installation instructions by system

Check the **installation instructions** for your specific solution.

Find the facade sheet based on:

- Cladding orientation
- Lunawood profile type
- Support battens material
- Fixing system

Go over the construction details in sheets 03.13 – 03.14 – 03.15 to optimize the key points.

---

---

04



### Tips for designing and installing a Lunawood facade

This is the last step to complete the cladding design.  
Check the tips for **designing and installing a Lunawood facade**.  
At this point you will find all the details that make the real difference.

How will the facade look in the future?  
Select one of the three design strategies to achieve the desired finish.

The design is ready!

---

05



### Materials handling and storage

Before starting to work on site, review this point in order to know:

How the cladding profiles should be stored on the construction site before installation.

The best way to handle the material during the cladding assembly.

---

06



### Tools and equipment needed

Use this checklist to ensure that you have **everything you need to install the facade**:

- Materials
- Tools
- Personal Protective Equipment (PPE)

On this point, you will also find some tips for working with Lunawood Thermowood.

Have a happy assembly!

---

---

**Facades don't age in  
the same way**

**01**

# 01.1. Examining the site

The local climate has a direct influence on the performance of a Thermowood facade. Sun exposure, humidity, rainfall, wind, snow and hail are the key factors in weathering: the aging process experienced by exposed wood.

## A. Sun exposure

As with any other exposed wood-based product, the colour of Lunawood Thermowood gradually fades, changing into a silver-grey tone due to ultraviolet radiation from the sun. The more solar radiation the facade is exposed to, the sooner the signs of photodegradation will appear.

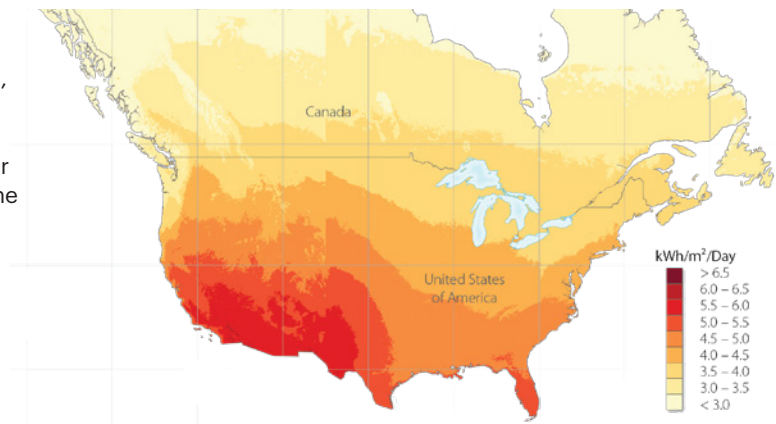

National Renewable Energy Laboratory (NREL)

## B. Orientation

In the northern hemisphere, the facades facing south, southeast, southwest and west are exposed to direct sunlight for many hours a day, making them weather relatively fast and unevenly.

By contrast, the facades facing north tend to weather more slowly and uniformly, because they are not directly exposed to sunlight. For this reason, facades facing north will also be prone to moisture.

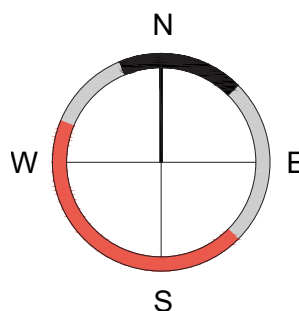
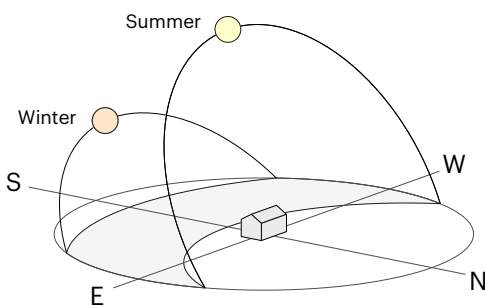

sun exposure  
intense  
moderate  
low

### C. Rainfall

Rain is the main source of moisture in a facade and the origin of most of the problems related to the durability of buildings.

Rainwater washes away the degraded material resulting from photodegradation and accentuates the greying process of exposed wood. A high moisture content in timber increases the probability of wood deterioration due to mould. Therefore, the design of the cladding must take into account moisture traps, rainwater drainage and drying through the ventilation of the facade's timber profiles. These factors are crucial in places with high rainfall.



Encyclopedia Britannica, Inc.

---

### D. The combined effect of wind and rain

Wind can be detrimental to timber cladding if combined with rain. The co-occurrence of wind and rain causes wind-driven rain that can lead to water penetration into the inner layers of the facade, increasing the moisture in the timber cladding profiles.

Considering the orientations of a building and the facades exposed to wind-driven rain and high solar radiation is crucial. Knowing the direction of the most frequent winds and how it interacts with rainstorms will help to improve the design of the cladding.

---

### D. Hot spots

Regions where a large quantity and frequency of precipitation are combined with high levels of humidity and mild temperatures provide an easy, comfortable life for fungi that cause decay.

Due to the increased risk of decay, special attention should be given to the design and detail of the facade when working in these regions. The designs should take into account adequate drainage of rainwater, moisture traps and faster drying with ventilation.





## 01.2. Select cladding orientation



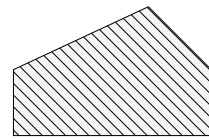
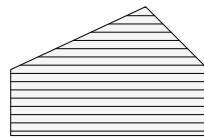
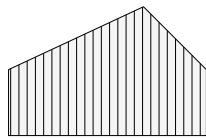

Facades are the face of a building. When choosing cladding orientation the aesthetic aspect is important, but other criteria such as climate, rainfall frequency or sun exposure should not be neglected. These aspects will be decisive when choosing the most suitable configuration for each project.

- Vertical orientation provides an optimal result because the profiles follow the rain direction and it makes it easier to clean.
- In a horizontal orientation cladding, water drainage is slower than in a vertical one due to gravity. There is an increased risk of rainwater penetration that may cause mould growing and moisture change movements. At the same time, installation may be simpler and cheaper.
- Diagonal orientation requires great skill and takes greater expertise and effort than the others. This orientation presents a higher risk of rainwater penetration through openings such as doors and windows. Larger amounts of material are also required.



Orientation	Vertical	Horizontal	Diagonal
Water drainage	● quick and uniform	● medium	● slow
Suitable for	Any location.	With caution in areas with high rainfall.	To be avoided in areas with high rainfall.
Project	 <p>Architect: Marià Castelló Martínez. Photo: Marià Castelló Martínez.</p>	 <p>Mercat Barcelona. Spain. Architects: Maria Manrique and Gisela Planas. Photo: Pere Virgili.</p>	 <p>Casa A, Portugal. Architects: REMA Arquitectos. Photo: Ivo Tavares Studio.</p>

## 01.3. Choose the type of profile

Type of Lunawood profile	Cladding orientation *			Cladding joint
	Horizontal	Vertical	Diagonal	
Tongue & Groove 	✓	✓	✓	Closed
Batten / rectangular 	(✓)	✓		Open Closed (in board on board design)
Shiplap 	✓	✓		Closed
Parallelogram 	✓			Open

\*) Note: The asterisk indicates that we recommend installation in the orientation chosen for the type of profile in the first column. Columns with no asterisk indicate that installation must be given special attention to control water drainage and avoid water traps. The solutions with no asterisk are not the best option in places with high rainfall.

(✓) For horizontal batten cladding, we recommend profiles with a sloping top edge to allow water drainage and prevent dirt accumulation (Parallelogram profile). See section 03.9.

■ Talo Senu,  
Finland,  
Architect  
Esmeralda  
Ståhlberg,  
Arkkittehtoitomisto  
Eark Oy.



■ Casa A, Portugal.  
REM'A Arquitectos.  
Photo: Ivo Tavares Studio

---

# Choose support battens and fixing system

02

## 02.1. Functions of the air cavity behind cladding

Once the type of profile has been selected, it is time to decide the support structure design for the facade. In addition to serving as a support, the substructure separates the timber cladding from the support wall, creating a dry and ventilated cavity in order to:

- Facilitate the drainage of the cladding profiles after wetting.
- Balance the moisture content between inner and outer faces of the cladding.
- Guarantee long-term durability of the support wall.

The ventilation cavity should maintain a consistent minimum thickness of 3/4". It will serve two main purposes: drainage and ventilation. In high humidity climates, we recommend a larger ventilation gap (see page 8). Before the installation of the support battens, a waterproof breathable membrane must be installed to protect the support wall. [See section 04 for general installation tips]

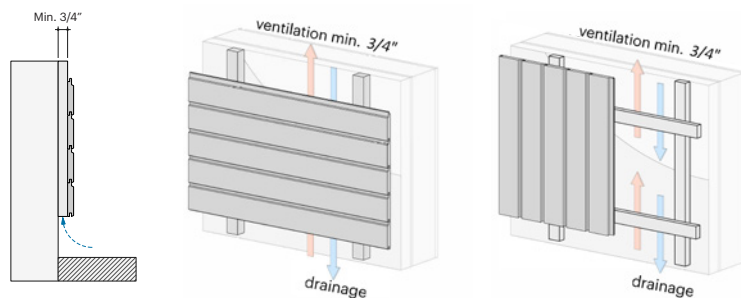

## 02.2. Choose the material for the support battens

The cladding support structure (support battens) must always be fixed to the backing wall structure. Depending on the type of the support wall, there are two options for the support battens material: **timber or metal**.

Type of support structure	Type of support wall	
	TIMBER STRUCTURE Timber frame or CLT	CONCRETE STRUCTURE MASONRY
Wooden support battens	Most common solution	Less common solution
Metal support battens	Less common solution	Most common solution

### A. Wooden support battens

Wooden support battens must be made of Lunawood Battens or preservative pressure treated timber to a Use Class 3 level of protection to ensure adequate durability. A naturally durable species suitable for a Use Class 3 may also be used.

• **In a timber support wall**, whether it is timber frame or CLT, Wooden support battens must be directly fixed to the load-bearing wall structure using fixings detailed in section 02.5.

• **In a concrete or masonry support wall**, Wooden support battens must be fixed to the load-bearing wall structure through metal brackets or screws with plastic anchors. The fixing guidelines are detailed in section 02.5.

### B. Metal support battens

Aluminium is the most common and frequently used material for the metal support battens, although stainless steel can also be used. The fixing guidelines are detailed in section 02.5.

## 02.3. Facade with wooden support battens

### A. Installing Lunawood cladding in horizontal orientation:

Horizontal cladding profiles are fixed to vertical battens creating a minimum ventilation gap of 0.75 inch. Vertical battens spaced max. 24" centres.

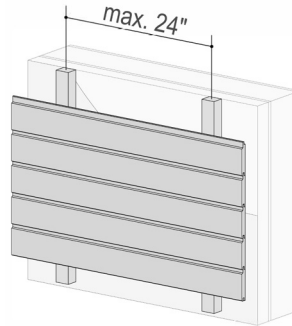

### B. Installing Lunawood cladding in vertical orientation:

In vertical orientation cladding, a double order of battens is used to provide adequate ventilation and drainage to the cavity. Vertical cladding profiles are installed onto horizontal battens. These horizontal battens are separated from the support wall to guarantee water evacuation using vertical battens creating a ventilation gap of a minimum size of 0.75 inch. It is recommended to space vertical and horizontal battens at max. 24 inch centres. We recommend installing the horizontal timber battens at an angle of 15° towards the interior of the cavity to ensure water drainage.

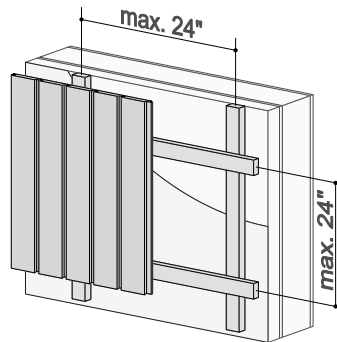

### C. Installing Lunawood cladding in diagonal orientation:

If the cladding profiles form an inclination angle greater than 45° with the horizontal, the installation guidelines are the same as those used in the vertical orientation and a double order of battens will be used. Facade profiles must be fixed to the horizontal battens, which must be attached to the vertical battens. Vertical battens need to create a minimum ventilation gap of 0.75 inch.

If the inclination angle of the profiles is less than 45° with the horizontal, the installation guidelines are the same as those used in horizontal orientation. In this case, a secondary order of battens is not necessary. Facade profiles must be fixed to the vertical battens. Vertical battens need to create a minimum ventilation gap of 0.75 inch.

For cladding in diagonal orientation, it is recommended to space battens at max. 16 inch centres.

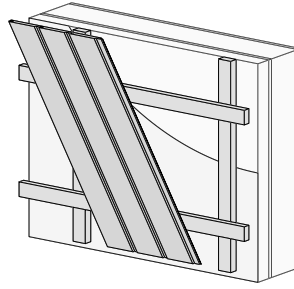

Inclination angle of the facade > 45°

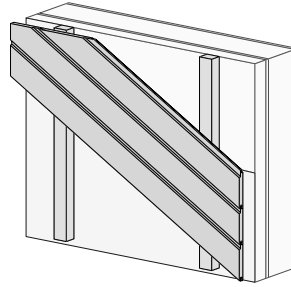

Inclination angle of the facade < 45°

## 02.4. Facade with metal support battens

### A. Installing Lunawood cladding in horizontal orientation:

Horizontal cladding profiles are directly fixed to the vertical aluminium battens spaced max. 24 inch centres, which are securely attached to the support wall using a system of aluminium brackets. The ventilation cavity a minimum of 0.75 inch.

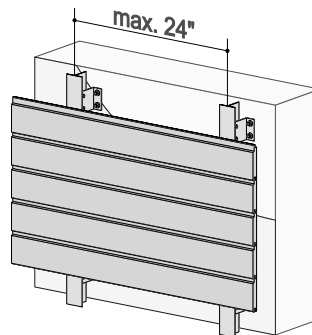

### B. Install Lunawood cladding in vertical orientation:

In vertical orientation cladding, a double order of battens is used to provide adequate ventilation and drainage to the cavity. Vertical metal battens are installed onto the support wall using a system of aluminium brackets. It is recommended to space metal battens at 24 inch centres.

Horizontal timber battens made of treated timber or naturally durable species, are attached to vertical aluminium battens to maintain a consistent minimum thickness of 0.75 inch. We recommend installing the horizontal timber battens at an angle of 15° towards the interior of the cavity to ensure water drainage.

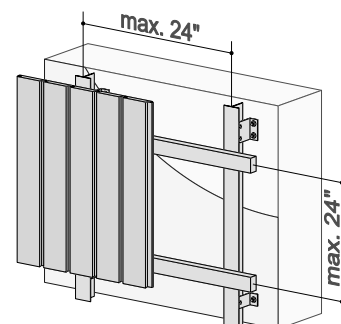

## 02.5. Choose the fixing system

The fixing system used to fasten support battens to the support wall depends on both the type of the wall (timber or concrete/masonry wall) and the material of the battens (timber or metal).

### A. Fixing Wooden support battens to the backing wall

Type of support wall

**TIMBER STRUCTURE**  
Timber frame or CLT

**CONCRETE STRUCTURE - MASONRY**

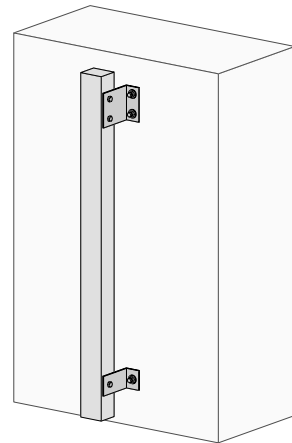
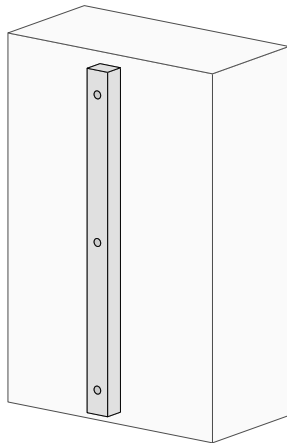
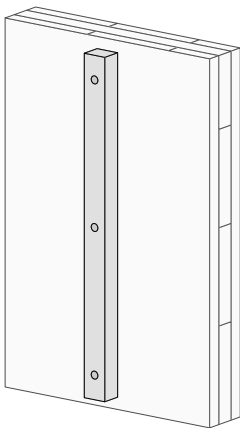

Direct fixing to a timber support wall using self-drilling screws suitable for timber made of AISI 304 (A2) stainless steel.

Direct fixing to a timber support wall using plastic anchors and screws suitable for use in concrete and masonry walls.

Fixing through a system of metal fastening brackets that allow adjusting the position of the battens regardless of the support wall flatness.



## B. Fixing metal support battens to the backing wall

Type of support wall

**TIMBER STRUCTURE**  
Timber frame or CLT

**CONCRETE STRUCTURE - MASONRY**

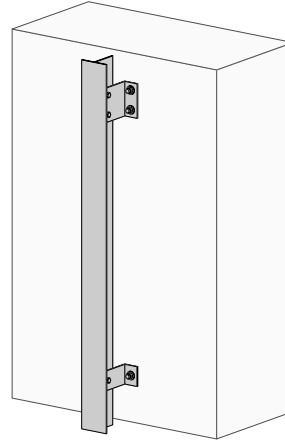
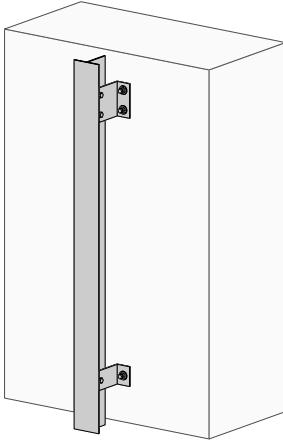

Fixing through a system of metal fastening brackets that allows adjusting the position of the battens regardless of the support wall flatness.

Fixing through a system of metal fastening brackets that allows adjusting the position of the battens regardless of the support wall flatness.

Fixing metal brackets to the backing timber wall using self-drilling screws suitable for timber made of AISI 304 (A2) stainless steel.

Fixing metal brackets to the backing concrete/masonry wall using plastic anchors and screws suitable for use in concrete and masonry walls.

## C. Fixing timber battens to timber battens

Direct fixing to a timber support wall using self-drilling screws suitable for timber made of AISI 304 (A2) stainless steel.

## D. Fixing timber battens to metal battens

Direct fixing using self-drilling timber-to-metal screw with self-perforating tip suitable for fastening to aluminium elements.

## E. Fixing metal battens to metal brackets

Direct fixing using screws suitable for use in aluminium, according to the instructions of the support structure manufacturer.

---

# Installation instructions by system

03

# 03.1. Vertical Tongue & Groove Wooden support battens

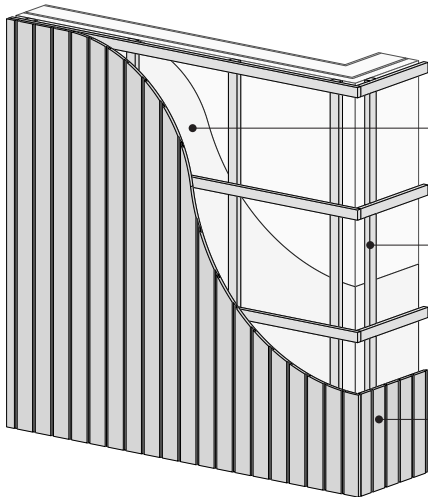

Waterproofing and breather membrane

Double order of wooden support battens made of Lunawood, pressure impregnated timber or naturally durable species  
- The minimum thickness of vertical support batten should be at least 0.75 inch

Vertical cladding: Lunawood tongue & groove profiles

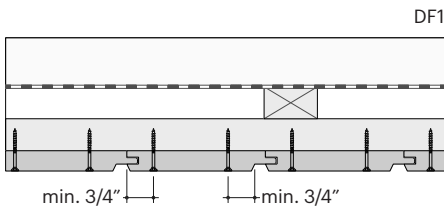

Profiles less than 6 inch width can be fixed with a single screw.

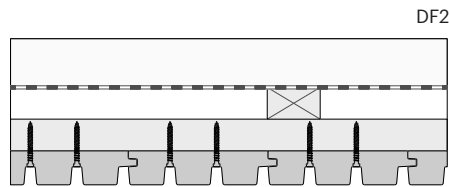

Screw head  $\varnothing_{max} = 0.27"$   
See length of the screw 04.1.

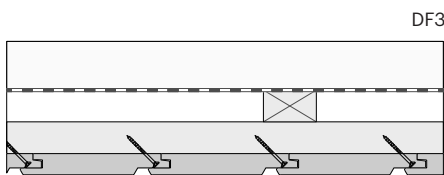

Hidden fixing only possible with HN profiles (Hidden Nailing). Use the V-shaped groove to position the screw.

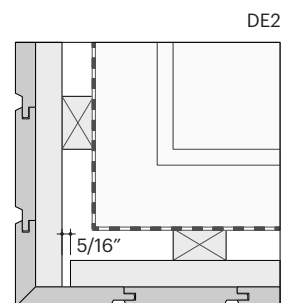
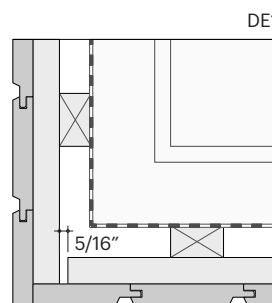
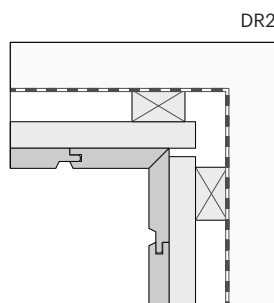
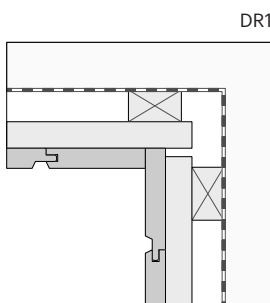

## 03.2. Vertical Tongue & Groove Metal support battens

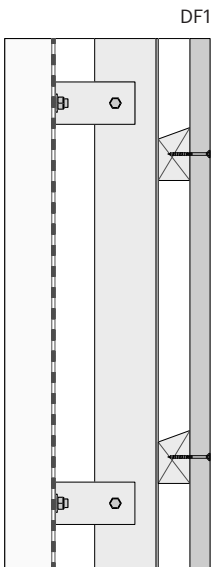
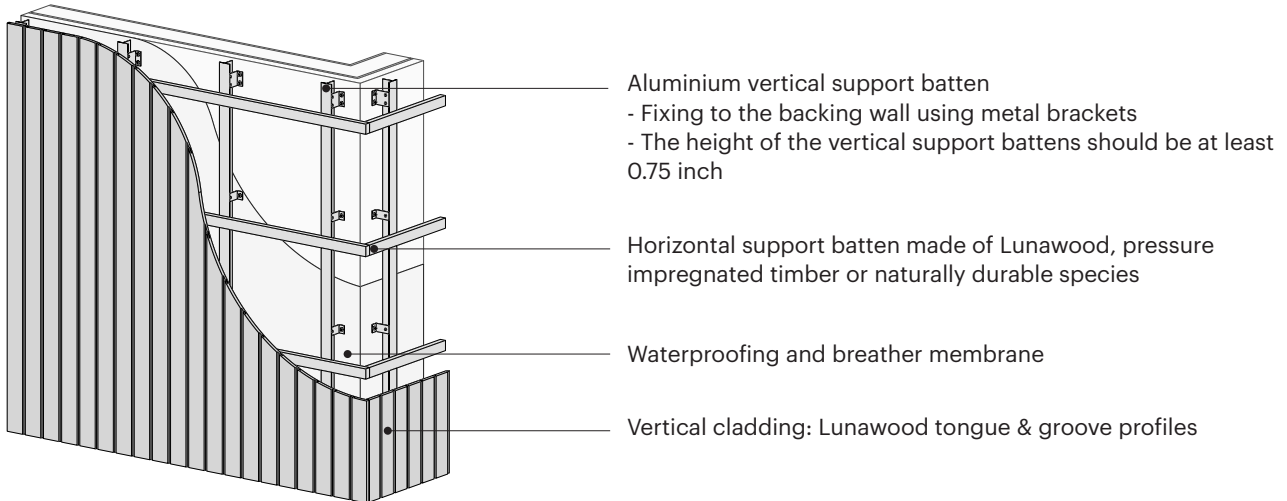

It is recommended to install the horizontal wooden support battens with a sloping top edge of at least 15° towards the interior of the cavity to shed water. [See DF1].

An additional insulation layer can be placed on the outside to improve energy efficiency of the facade. The breather membrane is installed on the outer surface of the insulation, with particular attention to correctly seal the membrane around the fixing brackets to protect the wall from water penetration.

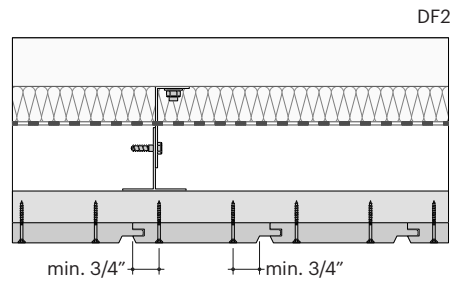

Profiles less than 0.75 inch width can be fixed with a single screw.

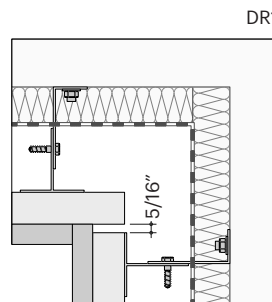
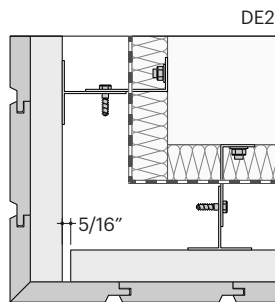
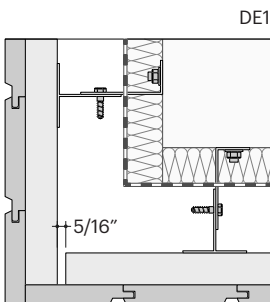

# 03.3. Vertical Battens

## Wooden support battens

### Visible fixing

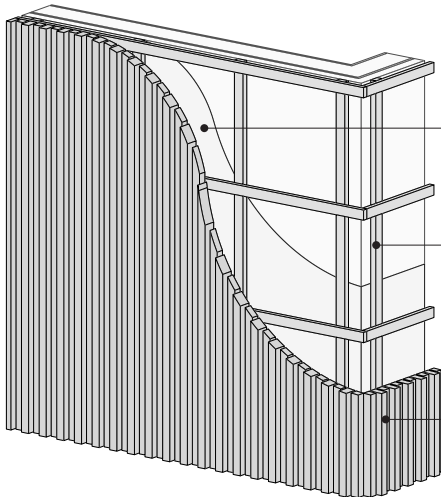

- Waterproofing and breather membrane
  - In open joint cladding battens assemblies, the breather membrane must be resistant to UV rays exposure.
- Double order of support battens made of Lunawood, pressure impregnated timber or naturally durable species
  - The minimum thickness of vertical support batten should be at least 0.75 inch
- Vertical cladding: Lunawood battens profiles

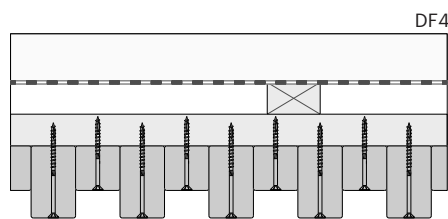
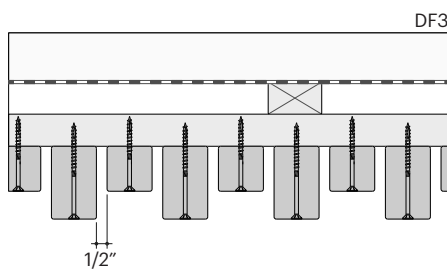
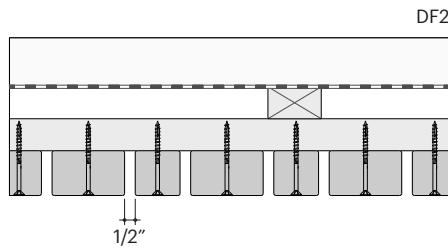
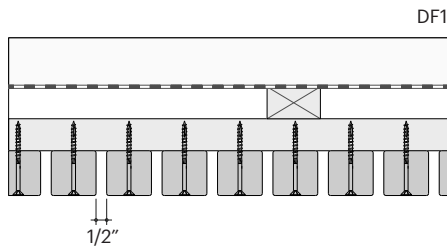

In open joints installation, the gap between battens must be equal or greater than 5/16" wide to avoid moisture traps.

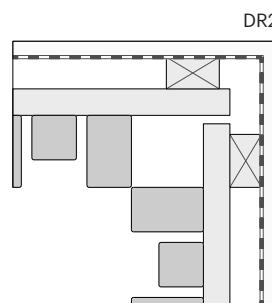
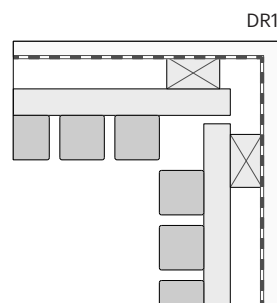
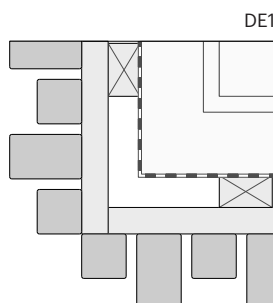

# 03.4. Vertical Battens

## Wooden support battens

### Hidden fixing

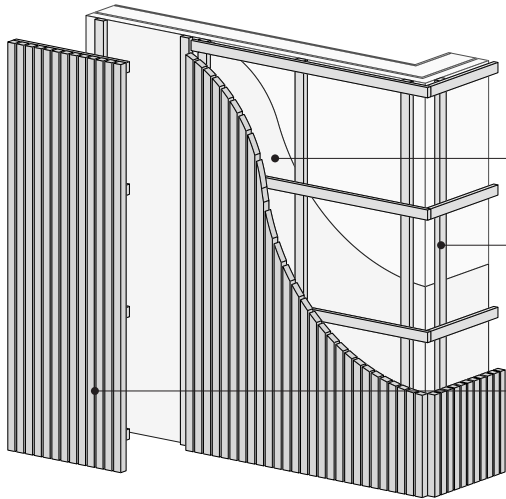

- Waterproofing and breather membrane
  - The breather membrane must be resistant to UV rays exposure.
- Vertical support batten made of Lunawood, pressure impregnated timber or naturally durable species
  - The minimum thickness of vertical support batten should be at least 0.75 inch
- Pre-assembled facade module
  - Vertical cladding: Lunawood battens profiles
  - Horizontal support batten made of Lunawood, pressure impregnated timber or naturally durable species

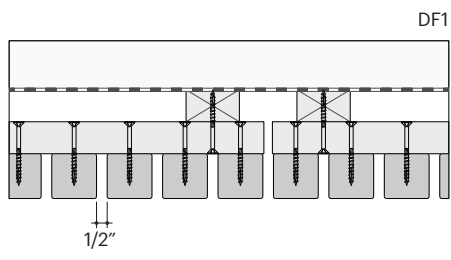

The gap between cladding battens must be equal or greater than 0.5 inch wide to allow fixing pre-assembled facade modules to vertical support battens.

If the backing wall allows the attachment of the vertical support batten in any position (for example, in CLT walls), a single horizontal support batten may be used. A double vertical support batten arrangement is recommended where two adjoining pre-assembled modules meet. [DF1 detail].

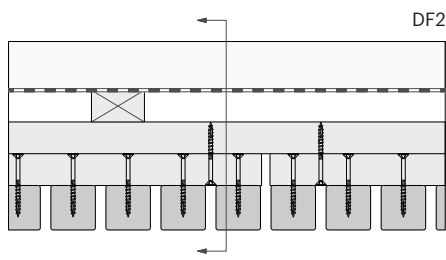

In timber frame walls, the vertical support battens must always be fastened directly to the structural components. In this case, an additional horizontal support batten must be used to fix the pre-assembled modules. [DF2 detail].

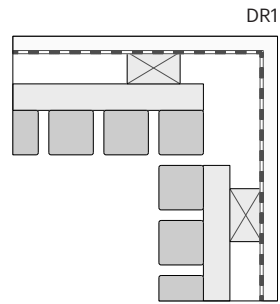
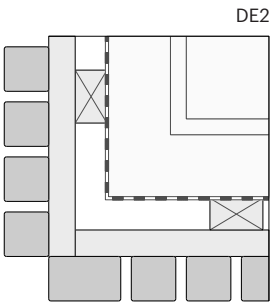
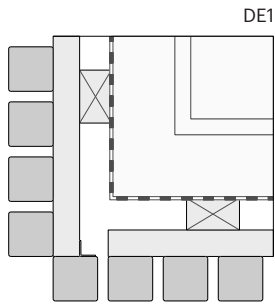
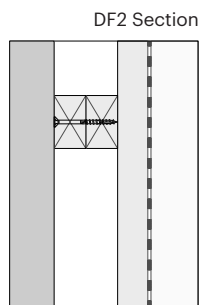

# 03.5. Vertical Battens

## Metal support battens

### Visible fixing

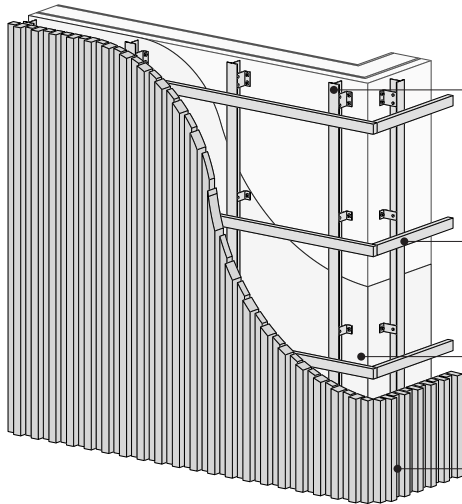

- Aluminium vertical support batten
  - Fixing to the backing wall using metal brackets
  - The height of the vertical support battens should be at least 0.75 inch
- Horizontal support batten made of Lunawood, pressure impregnated timber or naturally durable species
- Waterproofing and breather membrane
  - In open joint cladding battens assemblies, the breather membrane must be resistant to UV rays exposure.
- Vertical cladding: Lunawood battens profiles

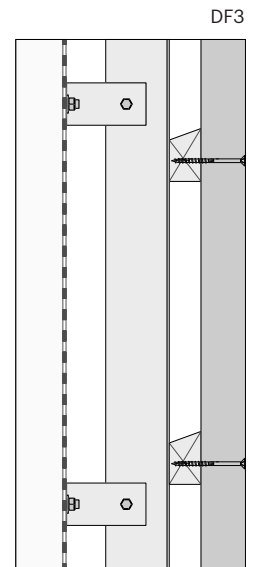
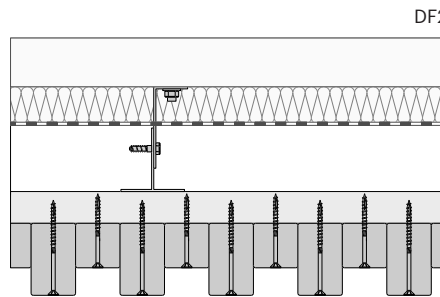
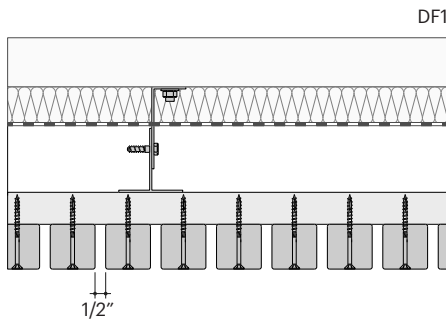

In open joints installation, the gap between battens must be equal or greater than 0.5 inch wide to avoid moisture traps. [See DF1].

It is recommended to install the horizontal wooden support battens with a sloping top edge of at least 15° towards the interior of the cavity to shed water. [See DF3].

An additional insulation layer can be placed on the outside to improve energy efficiency of the facade. The breather membrane may be installed on the outer surface of the insulation, with particular attention to correctly seal the membrane around the fixing brackets, to protect the wall from water penetration.

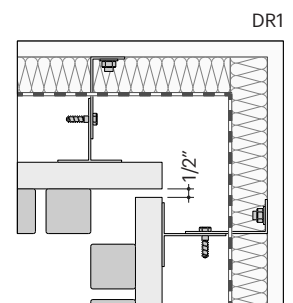
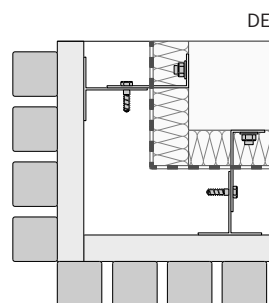

# 03.6. Vertical Battens

## Metal support battens

### Hidden fixing

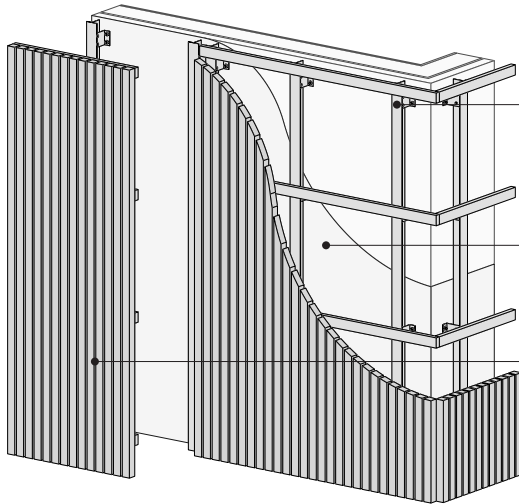

- Aluminium vertical support batten
  - Fixing to the backing wall using metal brackets
  - The height of the vertical support battens should be at least 0.75 inch
- Waterproofing and breather membrane
  - The breather membrane must be resistant to UV rays exposure.
- Pre-assembled facade module
  - Vertical cladding: Lunawood battens profiles
  - Horizontal support batten made of Lunawood, pressure impregnated timber or naturally durable species

DF1

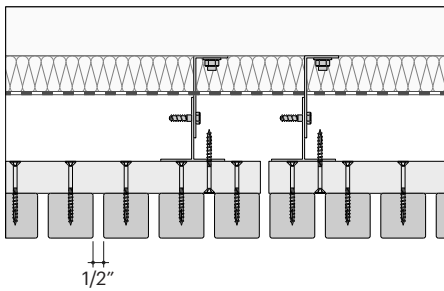

The gap between cladding battens must be equal or greater than 0.5 inch wide to allow fixing pre-assembled facade modules to vertical support battens.

DE1

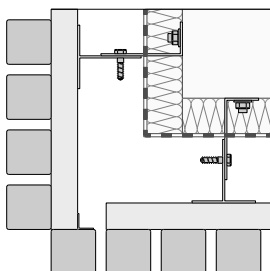

DE2

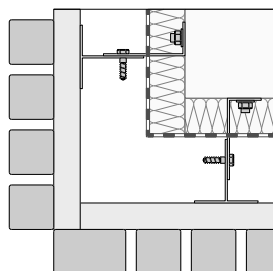

DR1

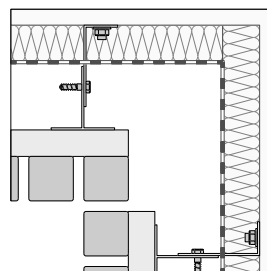



# 03.7. Horizontal Tongue & Groove Wooden support battens

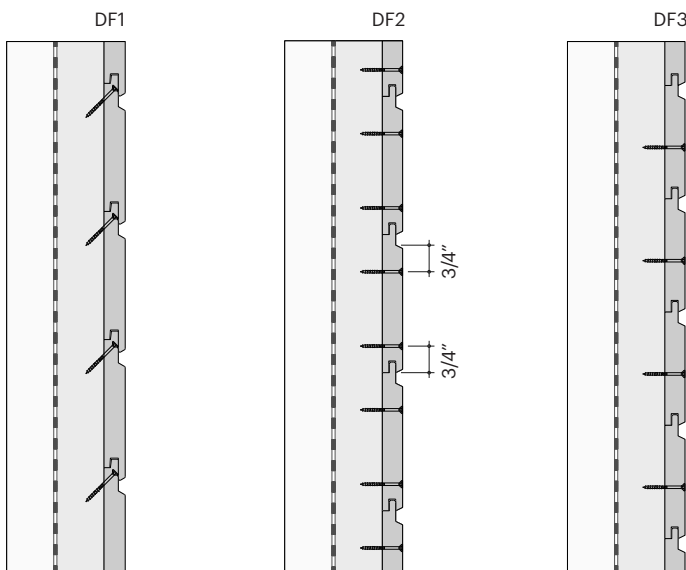
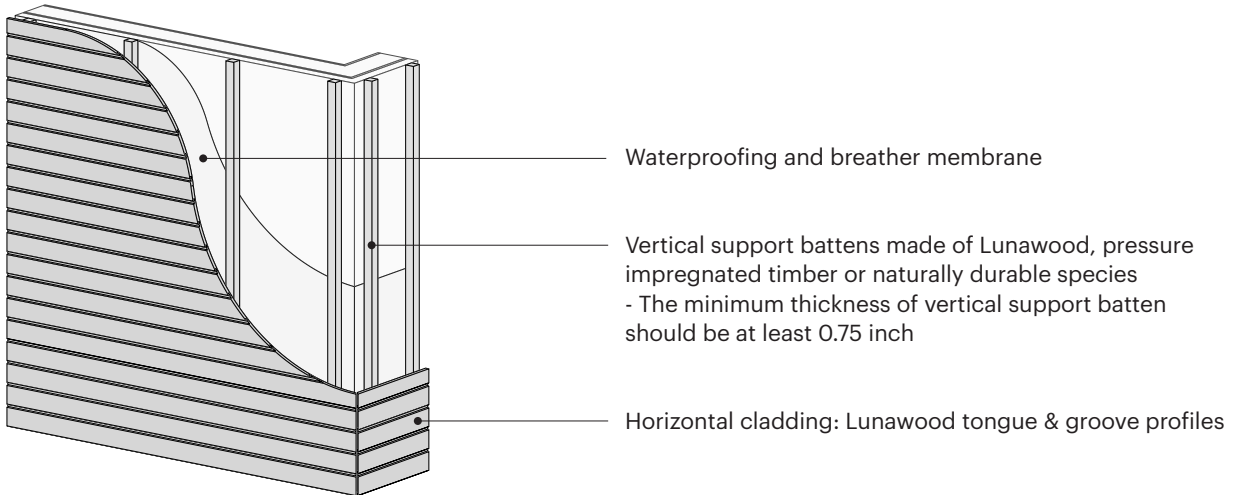

Profiles less than 6" width can be fixed with a single screw.

Hidden fixing only possible with HN profiles (Hidden Nailing). Use the V-shaped groove to position the screw. [DF1 detail].

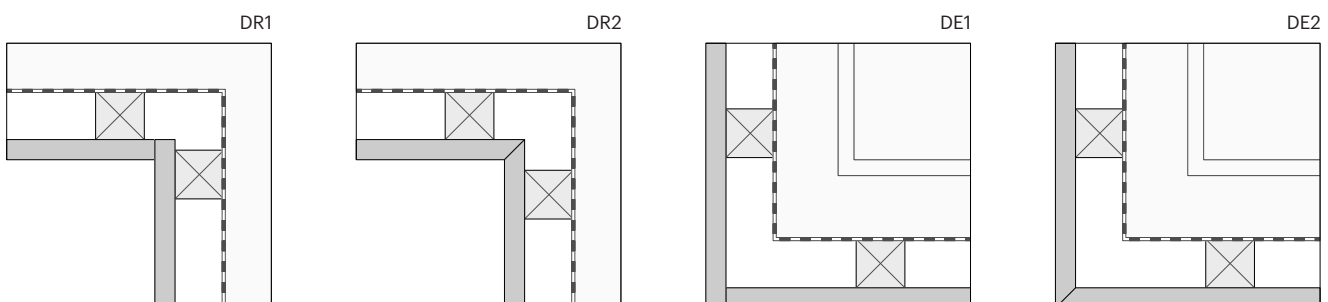

# 03.8. Horizontal Tongue & Groove Metal support battens

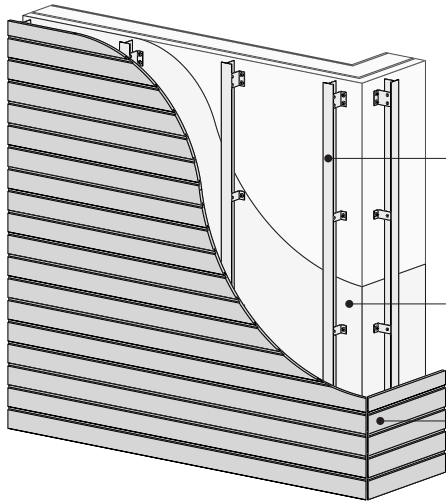

- Aluminium vertical support batten
  - Fixing to the backing wall using metal brackets
  - The height of the vertical support battens should be at least 0.75 inch
- Waterproofing and breather membrane
- Horizontal cladding: Lunawood tongue & groove profiles

DF1

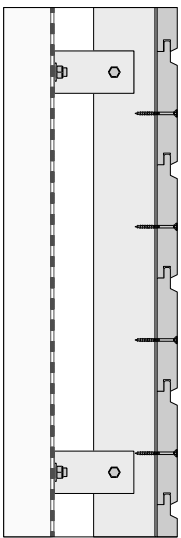

DF2

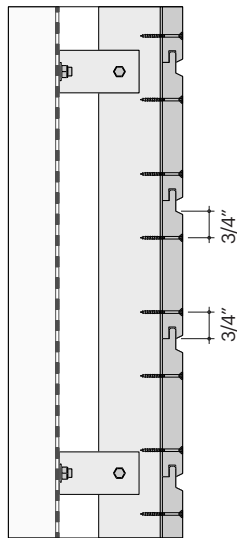

Profiles less than 6" width can be fixed with a single screw.

DR1

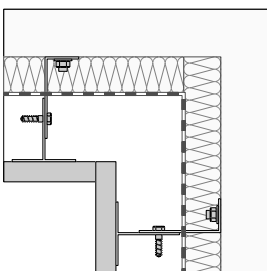

DR2

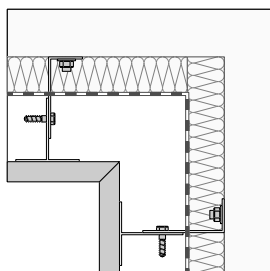

DE1

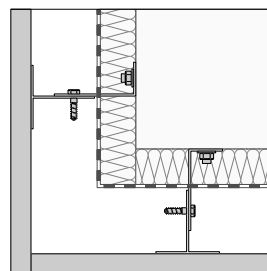

DE2

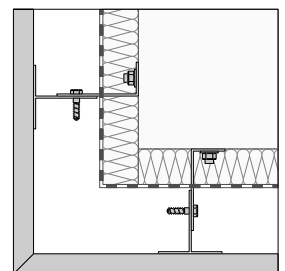

# 03.9. Horizontal Battens

## Wooden support battens

### Visible fixing

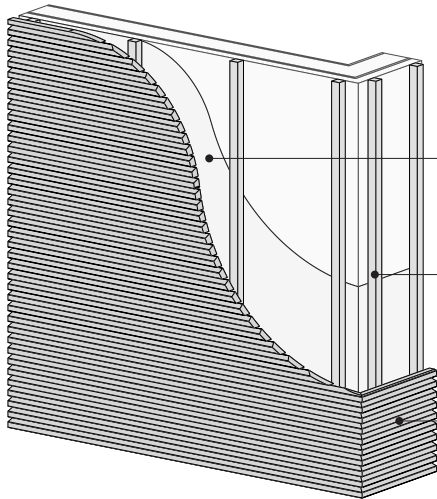

- Waterproofing and breather membrane  
- In open joint cladding battens assemblies, the breather membrane must be resistant to UV rays exposure.
- Vertical support battens made of Lunawood, pressure impregnated timber or naturally durable species  
- The minimum thickness of vertical support batten should be at least 0.75 inch
- Vertical cladding: Lunawood battens profiles

DF1

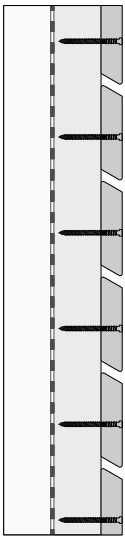

DF2

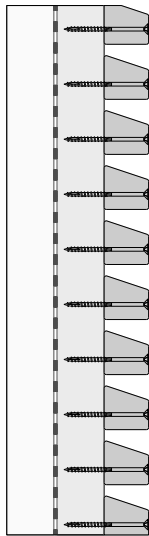

In horizontal battens cladding, profiles with a sloping top edge to allow water drainage and prevent dirt accumulation are recommended.

DE1

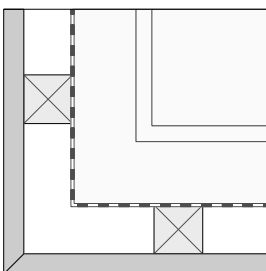

DR1

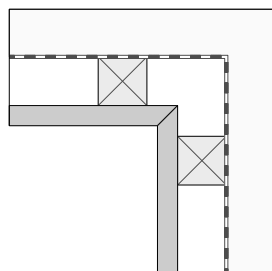

DR2

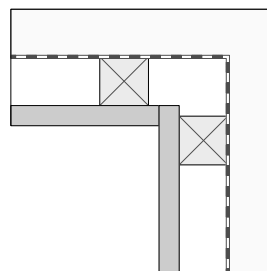

# 03.10. Horizontal Battens

## Wooden support battens

### Hidden fixing

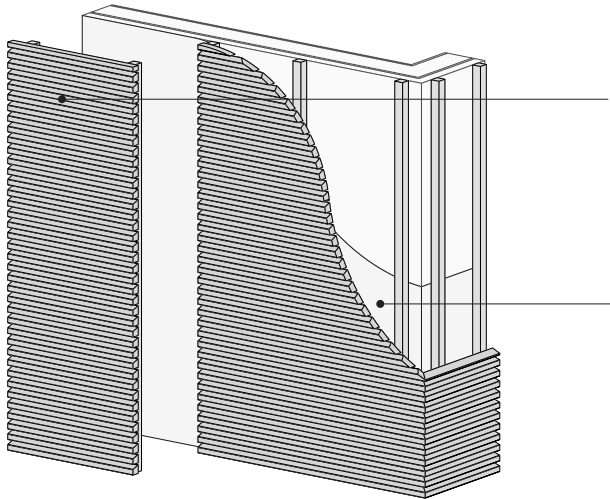

- Pre-assembled facade module
  - Horizontal cladding: Lunawood battens profiles
  - Vertical support batten made of Lunawood, pressure impregnated timber or naturally durable species'
  - The minimum thickness of vertical support batten should be at least 0.75 inch
- Waterproofing and breather membrane
  - The breather membrane must be resistant to UV rays exposure.

DF1

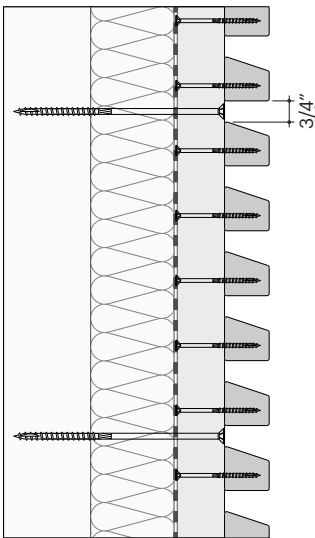

DF2

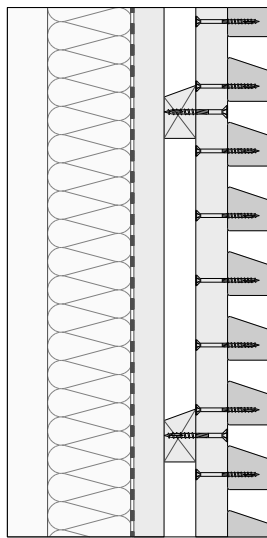

The gap between cladding battens must be equal to or greater than 0.75 inch wide to allow fixing pre-assembled facade modules to the structure.

If the backing wall allows the attachment of the pre-assembled facade module in any position (for example, in CLT walls), a single vertical support batten with minimum size of 0.75 inch may be used. [DF1 detail].

In timber frame walls, the vertical support battens must always be fastened directly to the structural components. In this case, an additional substructure with a double batten must be used to fix the pre-assembled modules. [DF2 detail].

DE1

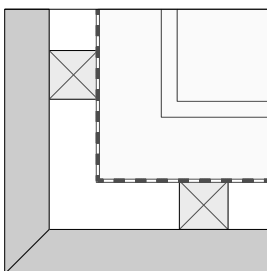

DR2

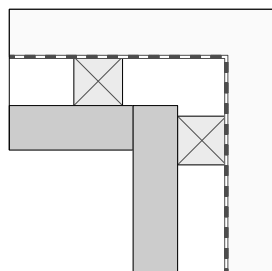

# 03.11. Horizontal Battens

## Metal support battens

### Visible fixing

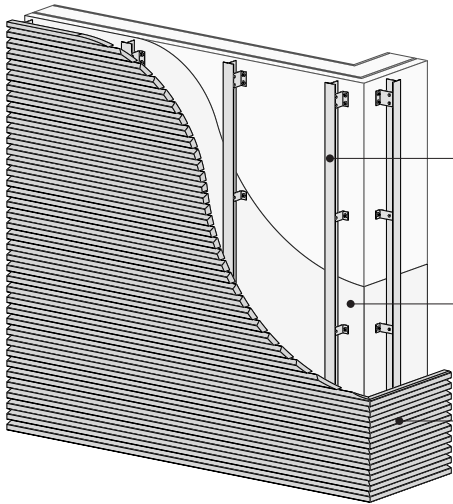

- Aluminium vertical support batten
  - Fixing to the backing wall using metal brackets
  - The height of the vertical batten supports should be at least 0.75 inch
- Waterproofing and breather membrane
  - In open joint cladding battens assemblies, the breather membrane must be resistant to UV rays exposure.
- Horizontal cladding: Lunawood battens profiles

DF1

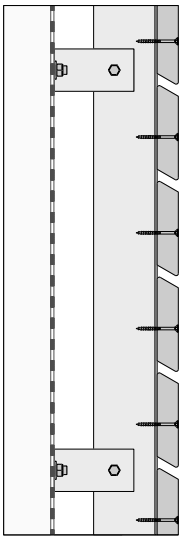

DF2

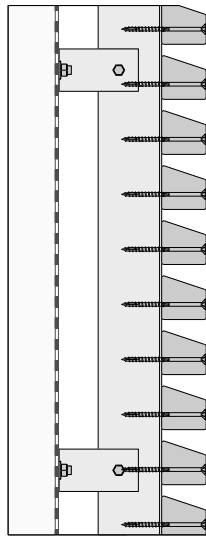

In horizontal battens cladding, profiles with a sloping top edge to allow water drainage and prevent dirt accumulation are recommended.

DE1

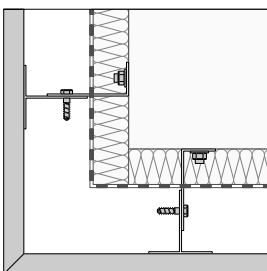

DR1

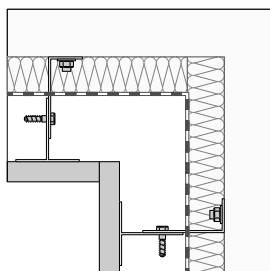

DR2

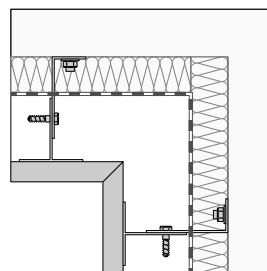

# 03.12. Horizontal Battens

## Metal support battens

### Hidden fixing

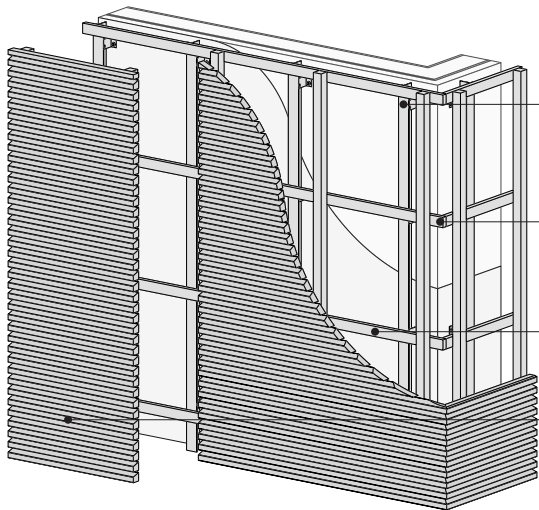

- Aluminium vertical support batten
  - Fixing to the backing wall using metal brackets
  - The height of the vertical batten supports should be at least 0.75 inch
- Horizontal support batten made of Lunawood, pressure impregnated timber or naturally durable species
- Waterproofing and breather membrane
  - The breather membrane must be resistant to UV rays exposure.
- Pre-assembled facade module
  - Horizontal cladding: Lunawood battens profiles
  - Vertical support batten made of Lunawood, pressure impregnated timber or naturally durable species

DF1

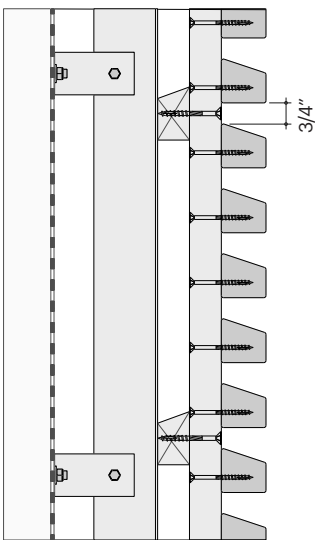

The gap between cladding battens must be equal to or greater than 0.75 inch wide to allow fixing pre-assembled facade modules to the structure.

DE1

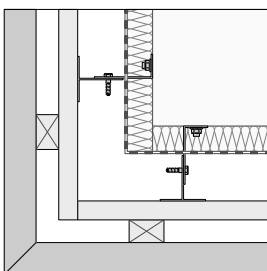

DR2

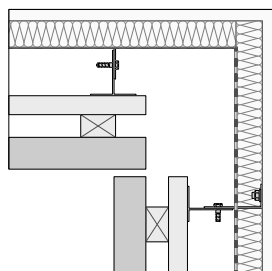

# 03.13. Construction details – top and bottom edges

## Top edge facade detail

It is recommended to leave a free opening of at least 0.75 inch wide between cladding profiles and eave, roof or any flashing or finishing element to allow cavity ventilation.

DC1

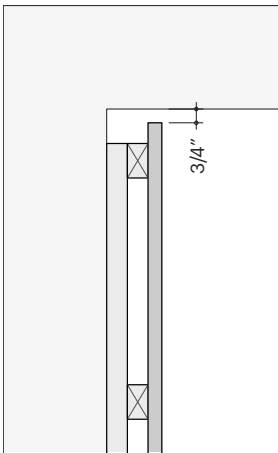

## Bottom edge facade detail

Leaving at least 12 inch between the bottom edge of the cladding profiles and the ground is recommended when using pavements that favour rainwater splashing and in areas with high rainfall. [See DA1].

DC2

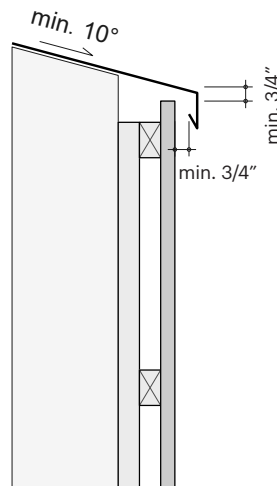

The facade profiles may be placed closer to the ground, keeping a minimum distance of 8 inch, when the lower surface is covered with gravel. [See DA2].

In case it is needed to reduce the separation between bottom edge cladding and the ground, a horizontal facade orientation may be used. Horizontal cladding allows the replacement of the lower profiles if necessary. [See DA3].

Cutting the ends of vertical cladding profiles to a 30° angle will allow moisture to drip from the ends of the boards more easily and reduce the chance that water could be held there trough surface tension.

DA1

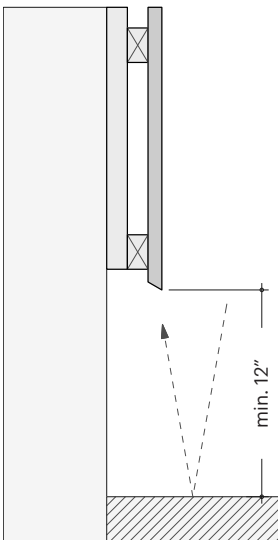

DA2

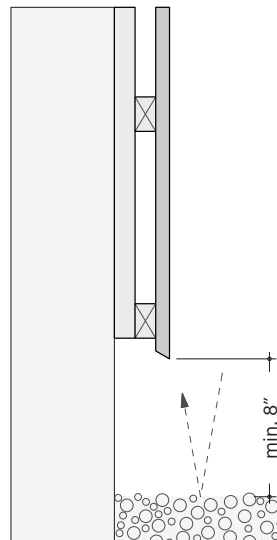

DA3

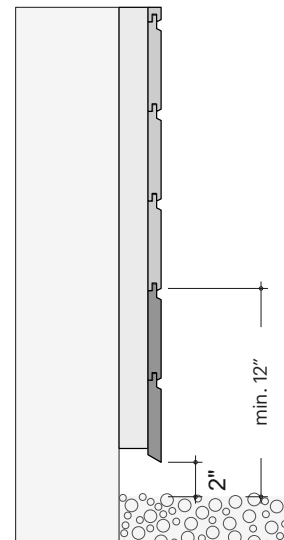

## 03.14. Construction details – insect mesh

DC3

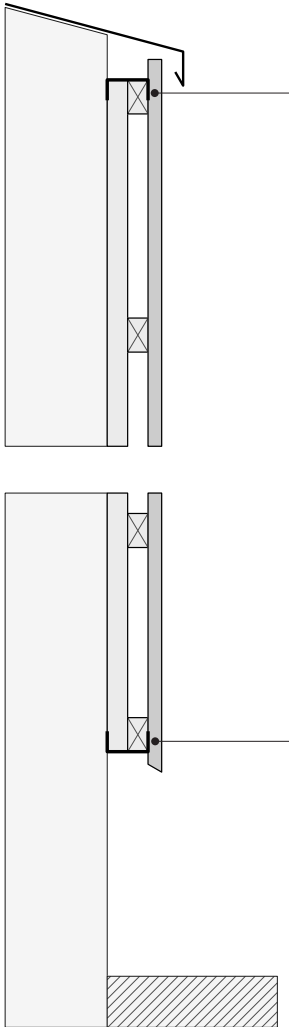

### Insect mesh

To prevent insects and small rodents from entering into the cavity, it is recommended to fit the insect mesh on closed-joint claddings (facades with tongue & groove profiles or facades without gaps between battens).

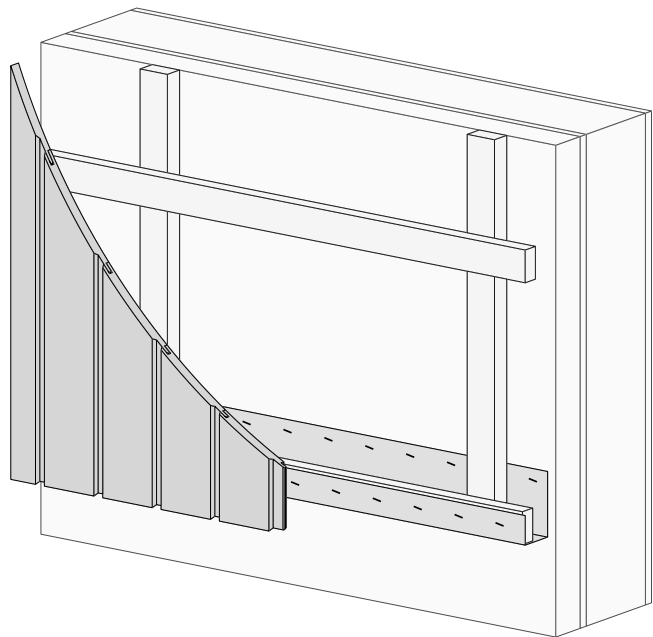

DA4



# 03.15. Construction details – windows openings

DV1

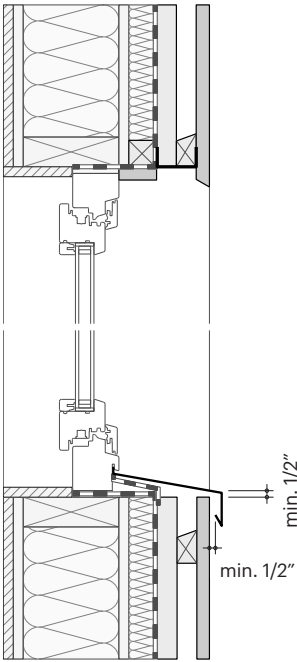

DV2

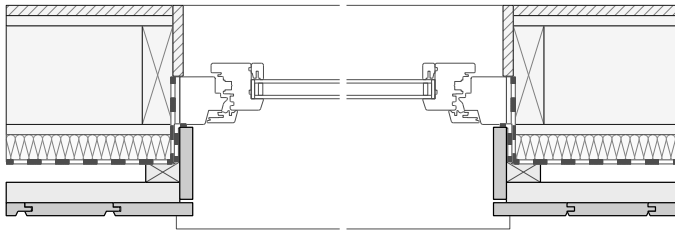

DV3

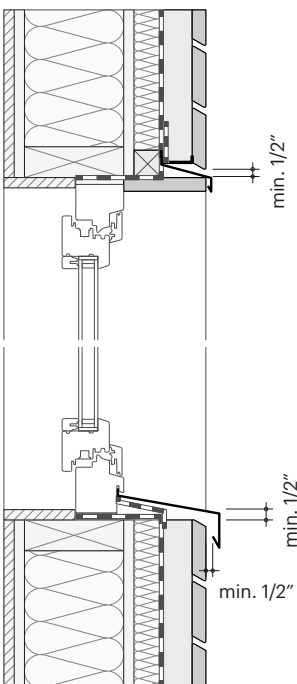

DV4

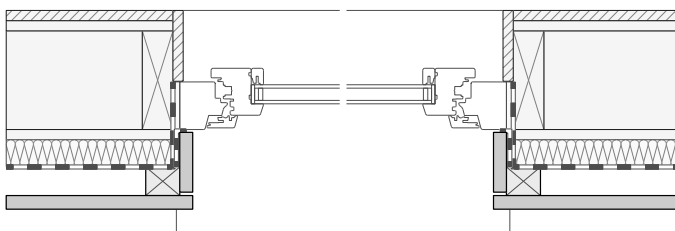

---

# Tips for designing and installing a Lunawood facade

04

## 04.0 Using side of Lunawood Thermowood

The using side of Lunawood Thermowood is determined by the wood species. We have already taken this into consideration when planing the wood.

We use the heart side for the using side in our pine facade products because it is more durable and reduces the risk of delamination.

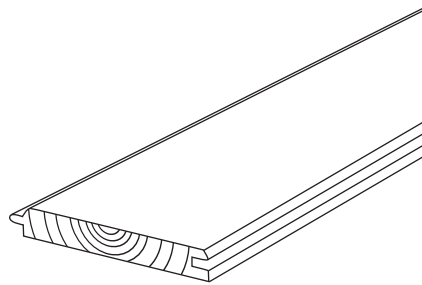

Heart side as using side in Lunawood's Nordic pine products

Lunawood's Nordic spruce facade products are planed so that the sap side is the using side. The straight grain structure of spruce allows the use of the sap side without the risk of delamination.

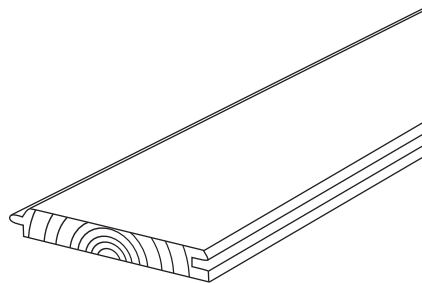

Sap side as using side in Lunawood's Nordic spruce products

### Lunawood Battens

Lunawood Battens are made of Nordic pine. They are graded on three sides (heartwood side and edges). We recommend installation at the edges.

# 04.1. Fix Lunawood facade profiles correctly

To fix Lunawood cladding profiles it is recommended to use self-drilling screws suitable for timber or aluminium, depending on the material chosen for the support battens. Fasteners must be at least of AISI 304 quality (A2 class) stainless steel.

### Recommendations:

- Lunawood cladding profiles are recommended to be fixed with Fixing Group Solida 1 stainless steel screws or similar.
- Screw length should be greater than 2x the thickness of the cladding profile, and less than the sum of the facade and support battens thicknesses.
- Pre-drill the screw holes when the fixing point is less than 3 inch from the end of the cladding profile; this avoids the risk of cracks appearing during installation.
- Fasten screws to the correct depth. The screw head must be flush with the cladding profile surface in order to prevent splits, surface staining and moisture traps.

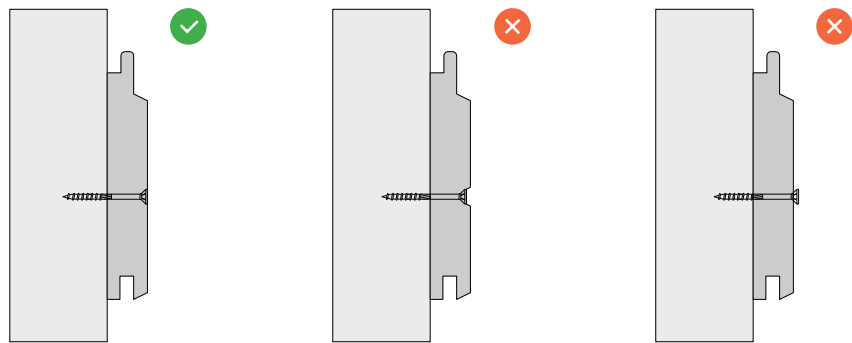

- Use one fixing at each cladding/batten intersection when the cladding profile is less than 6 inch wide. Use two fixings when the cladding profile is wider than 6 inch. Always respect the edge distances recommendations.

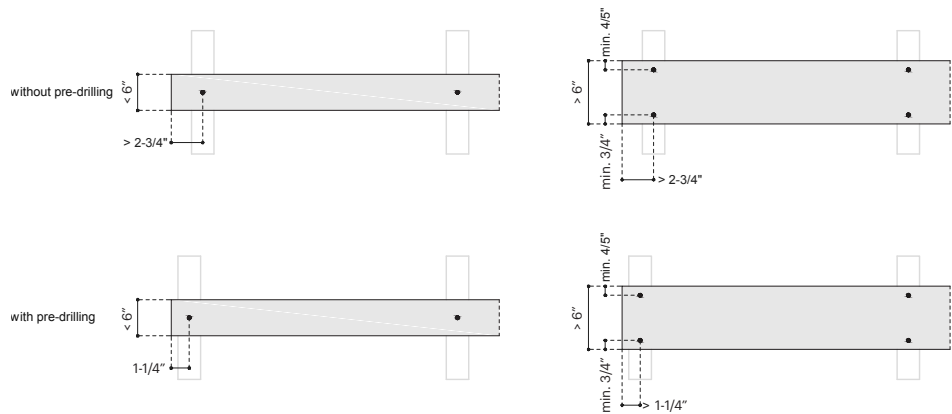

- It is recommended to fix the cladding profiles in at least 3 support battens.

## 04.2. Check the distance between ground and cladding

Lunawood Thermowood cladding profiles are suitable for Use Class 3 (EN 335:2013), in all those situations where timber is in an exterior environment, above ground and exposed to the weather. Lunawood Thermowood products are not recommended for use in direct contact with the ground.

The lower part of the facade is a critical area. It is exposed to rainwater splashing and receives a large amount of runoff water over its surface, running down along the facade. In order to prevent damage from excessive moisture in this area, respect the minimum distances between the bottom edge of the cladding and the ground, listed in section 3.13. Construction details | Top and bottom edges.

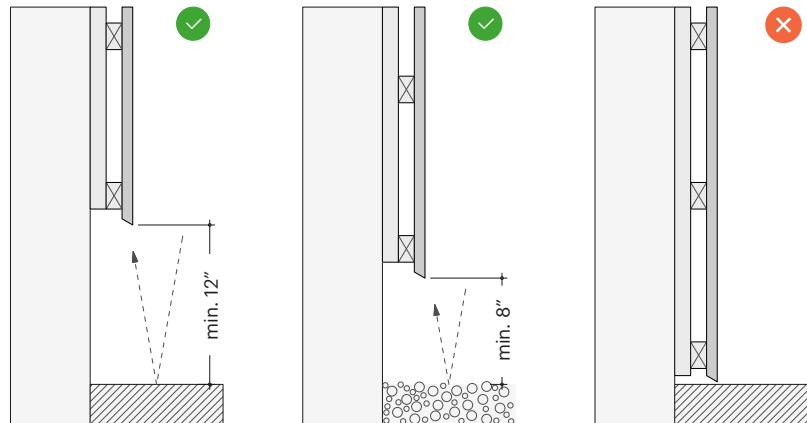

## 04.3. Ensure adequate ventilation of the air cavity behind cladding

Between the backing wall and the Lunawood Thermowood cladding, a ventilated air cavity must be designed to ensure an adequate performance of the facade. The ventilation helps to dry the cladding after rainfall, balancing the moisture content of the inner and outer faces of the profiles and improves the protection of the backing wall.

The ventilation gaps must have a minimum width of 0.75 inch at the narrowest points to ensure thorough ventilation in the cavity. These gaps could be reduced to a minimum width of 0.5 inch, but only in the perimeter of the window openings.

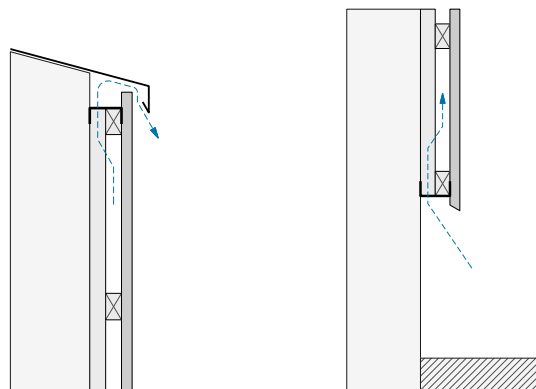

## 04.4. Protect the support wall

It is recommended to protect the support wall against wet weather and air penetrations using a **waterproof and breather membrane**. This layer, which is installed before the support battens, provides waterproofing and airtightness whilst allowing moisture to escape. Use flexible tape for sealing breather membranes overlaps according to the manufacturer's instructions.

Install a self-sealing nail point tape made of butyl or closed-cell polyethylene between battens and breather layer to ensure that the membranes are completely hermetically sealed at the points where support battens screws pass through the membrane.

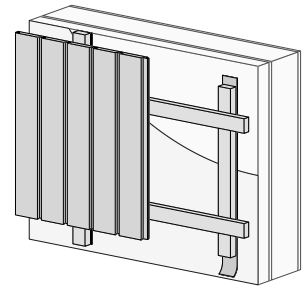

---

## 04.5. Install insect mesh

To prevent insects and small rodents from entering into the cavity, it is recommended to fit the insect mesh on closed-joint claddings (facades with tongue & groove profiles or facades without gaps between battens).

The perforated closure or insect mesh made of aluminium, stainless steel or plastic, must allow the free airflow through its holes.

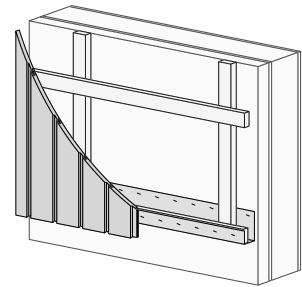

---

## 04.6. Avoid moisture traps

The design of the cladding and its details must facilitate the evacuation of rainwater from the facade surface as quick and easily as possible. Horizontal surfaces must be avoided in order to reduce rainwater accumulation.

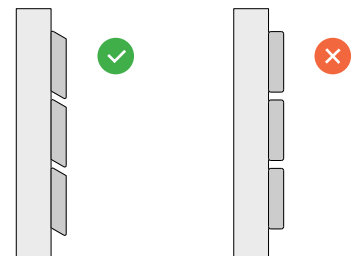

## 04.7. Pay attention to key points

In order to provide additional protection, apply an end grain sealant product designed to block moisture uptake through the end grain, after cutting timber and at the ends of the profiles: corners, ends of vertical cladding profiles.

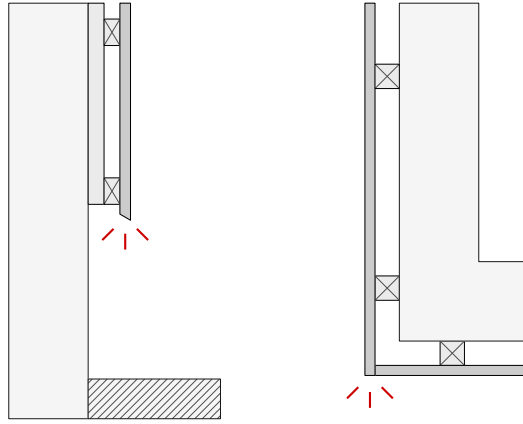

---

## 04.8. Use breathable, diffusion open, coatings

Lunawood Thermowood cladding can be finished in the same way as unmodified timber cladding. The chosen surface coating must protect from UV radiation and allow water evaporation.

Lunawood Thermowood profiles can be treated with tinted or pigmented wood oil, transparent or pigmented translucent wood stain, wax, varnish or paint. Notice that linseed oil is not suitable for Thermowood. In order to maximize the lifespan of the wood and coating, it is necessary to choose a breathable finish that creates a porous film on the surface of timber.

Pigmented finishes protect timber against photodegradation, have a longer service life and are more resistant to UV radiation than transparent or translucent finishes.

The surface treatment can be applied before installation to ensure the best result, but it is also possible to apply the finish immediately afterwards, always according to the recommendations given by manufacturers of coatings.

Before applying the coating, moisten the profiles surface to open the pores and make it easier for the finish product to penetrate better into the timber.

## 04.9. Consider weathering process during the design

All timber exposed to the elements experiences changes of colour in the surface. It is a natural and healthy process, due to the inherent properties of wood and mainly caused by UV radiation from the sun.

At the time of installation, Lunawood Thermowood profiles show a dark-brown colour. Over time, due to exposure to sunlight, the colour of thermally modified timber fades and gradually changes to a silver-grey tone.

Microscopic and macroscopic cracks produced by the difference in moisture content between inner and outer faces of the cladding may also appear on the surface, although this effect is lower in Thermowood thanks to the thermal modification process.

All of these effects caused by photodegradation are superficial and completely normal. They only affect aesthetics and do not reduce any of the properties of Thermowood.

■ Nursery Savannen, Denmark.  
Nordic Office of Architecture.  
Photo: Kristine Mengel.



Timber greying process is influenced by many factors, but it can become visible in a relatively short period; from 3 to 6 months after the facade installation.

To incorporate the natural aging of timber in the design of the building, it is important to take into account the following instructions:

- Aging effects are not homogeneous. They are more intense in facade areas more exposed to sunlight, humidity and rain.
- Facades that receive a greater amount of sunlight experience a more intense and irregular weathering (SW – S – W).

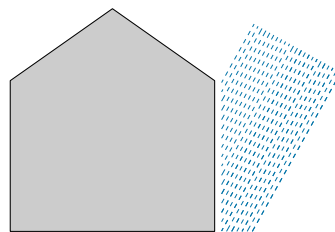

- Facade areas protected from rainfall (under eaves, overhangs, porches...) or less sun-exposed walls (north facing walls in the northern hemisphere), tend to weather slowly.

- The cleaner the design, the more homogeneous the weathering will be. Buildings without eaves tend to

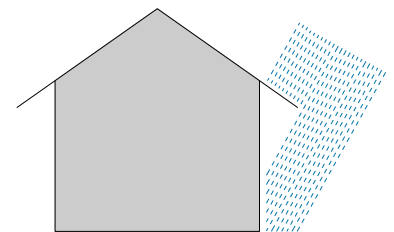

- get wettest at the top, so those areas weather relatively fast but the change of colour is uniform. If there are eaves, the change of colour is more irregular.

- Facades with horizontal orientation experience a more heterogeneous greying than vertical orientation facades.



## 04.10. Three strategies to achieve the desired finish

### 1st strategy: original appearance

If the project aims to maintain the original appearance and tone of the Thermowood profiles, apply a transparent or translucent surface coating with protection against UV radiation and color pigmentation, following the product manufacturer's guidelines. The frequency and need of maintenance treatments will depend on the type of finish product, climate, surface orientation and the degree of ultraviolet radiation exposure.

In order to revert the change of the exposed timber, it is possible to wash the surface of discoloured timber, taking care to apply only enough water pressure to remove the grey surface without damaging the rest of the profile. Before applying any finishing product, the timber must be completely dry.

Forum Braga, Portugal.  
Barbosa & Guimarães Arquitectos.  
Photo: Tiago Casanova.





**I Bosc d'en Pep Ferrer, Spain.**  
Marià Castelló Martínez.  
Photo: Marià Castelló Martínez.



**Casa em São Pedro Fins, Portugal.**  
António Eurico Moreira e Silva.

### 2nd strategy: natural greying

If the goal is to integrate the natural weathering in the design of the building, consider the indications given in section 04.9.

To achieve a gradual change of colour in exposed facades, use a pre-aged appearance coating that simulates the natural silver-grey patina taken by wood after years of weathering. Lunawood Pre-Greyed profiles are finished with a mineral surface treatment made of silicates, mineral pigments and lignin. The finish gives the Thermowood a naturally beautiful, silver-grey patinated wood appearance from the first day. After several years, the coating disappears revealing beneath the natural grey-tone of the aged wood.

### 3rd strategy: opaque paint

Lunawood Thermowood can also be painted with opaque finishing products. Opaque paints form a film on the surface of the wood, covering the grain and protecting it from photodegradation. This type of coatings have a more long-lasting effect than transparent or translucent coatings, managing to extend the period for maintenance treatments.

Follow this strategy painting wood with an opaque silicate or acrylic paint coating suitable for exterior wood. Unlike conventional paints, silicate or acrylic opaque paint is highly breathable and provides quick facade drying after the rain.



**Villa Vuurlijin, Netherlands.**  
Hoogeveen Architecten. Photo: Arjen Hoogeveen.



**Casa Duplio, Finland.** SAIKA Design.

---

# Materials handling and storage

05

## 05.1. How to store timber on the construction site

To preserve the high quality of Lunawood Thermowood products, the following recommendations must be followed when material arrives at the construction site:

- Store timber in a dry ventilated place, protected from direct sunlight and precipitation. Due to UV radiation, wood exposed to sunlight may experience a change of colour.
- Completely and tightly cover the stored material with UV-protective wraps before and during installation. It is recommended to store Lunawood Thermowood in its original packaging.
- Lunawood timber packages must be kept ventilated and separated from the ground a minimum of 3 inch high. Use battens to create an even base that allow airflow below the package.
- They must be placed in a horizontal and dry surface, with a sufficient number of supports to avoid an excessive bending.

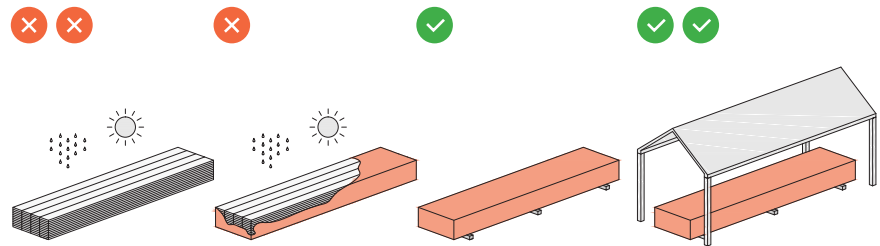

## 05.2. Handle with care

- Place the materials in a secure and stable way to prevent deterioration during storage.
- Handle and install the product with care to avoid knocking against hard surfaces.
- Tongue and groove profiles must be handled with care to avoid damage during the material unloading and transport. The edges of this type of profiles are delicate points that could be damaged if handled roughly.

---

# Tools and equipment needed

06

## 06.1. Materials

- Lunawood Thermowood profiles
- Support battens made of treated timber or naturally durable species
- Metal support battens
- Metal brackets
- Self-drilling screws suitable for timber made of AISI 304 (A2) stainless steel
- Fasteners suitable for use in concrete or masonry wall
- Self-sealing nail point tape made of butyl or closed-cell polyethylene
- Waterproof and breather membrane
- Sealing tape suitable for breather membrane
- Insect mesh
- Finish coating for exterior timber
- End grain sealant product

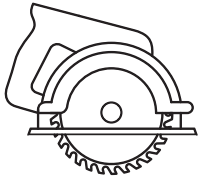

## 06.2. Tools

- Measuring tape
- Ruler
- Laser level
- Precision level
- Pencil
- Powder marker
- Hygrometer or moisture meter for wood
- Lever clamps
- Cutter
- Carpenter's square
- Screwdriver or nail gun
- Drill
- Twist drill bits
- Circular saw
- Mitre saw



## 06.3. Personal Protective Equipment (PPE)

- Protective glasses
- Anti-dust mask with active carbon filter
- Protective gloves suitable for wood working
- Working clothes
- Safety footwear
- Helmet for workplace safety
- Harness
- Fall protection device

---

## 06.4. Tips for working with Lunawood Thermowood

### Planning

When working with Thermowood, set the wood planer as for working with hardwood species. Planning speed for Lunawood Thermowood should be less than used for working unmodified wood. Pay attention to feed roll settings and pressures configuration to prevent the risk of cracking the profiles surface.

### Sanding

No additional sanding is required because the surface quality of Lunawood Thermowood is excellent after planing.

### Sawing

The sawing of Thermowood is easy and does not differ from working with untreated wood.

### Pre-drilling

Pre-drill the screw holes when the fixing point is less than 3 inch from the end of the cladding profile. This avoids the risk of cracks appearance during installation.

### Screwing/nailing

Fasten screws to the correct depth. The screw head must be flush with the cladding profile surface in order to prevent splits, surface staining and moisture traps, as well as for aesthetic reasons. When a nail gun is used, make sure it has depth control regulation.

# LEGAL DISCLAIMER – Lunawood Collection – Facade Installation

## Product characteristics

The facade products within the Lunawood Collection are carefully manufactured and inspected to ensure quality. However, these are natural wood products and are subject to variations in weight, density, color, grain. Wood facade is naturally subject to dimensional changes as the moisture content in the wood fluctuates with humidity in the air. Swelling, shrinkage, surface checking, and other movement of individual pieces are normal occurrences in wood facades. Nevertheless, with Lunawood exterior claddings the swelling and shrinkage are minimal compared to kiln dried Scandinavian Pine or Spruce.

## Before installation

Facade products within the Lunawood Collection should be stored and treated according to Lunawood guidance, see Lunawood technical guideline [www.lunawood.com](http://www.lunawood.com)

An adequate air circulation behind the facade must be ensured in order to have long lasting Lunawood facade.

Use safeguards for personal protection (safety glasses, dust mask and gloves) always when with Lunawood Thermowood. We recommend an active carbon filter dust mask when drilling, sawing, sanding, or machining Thermowood.

## Installation

Lunawood installation guidance must be followed.

Local building codes must be consulted when building a facade with facade products within the Lunawood Collection. Facade must be built in accordance with regulatory requirements. Most countries may require building permits.

Drawings and schematics used to show where to place screws are for reference purposes only.

## Maintenance

Like all timber products Lunawood Thermowood will go grey upon exposure to UV if left untreated, and in time may show some fine cracks or splits on the surface. In order to preserve and maintain the original appearance apply a surface coating that are suitable for Thermowood. Consult your local surface treatment manufacturer and see Lunawood General Maintenance Guide for facades on [www.lunawood.com/us/download-centre](http://www.lunawood.com/us/download-centre).

## Other information

Technical information contained herein is furnished without charge or obligation and is given and accepted at recipient's sole risk. Because conditions of use may vary and are beyond our control, Lunawood makes no representation about, and is not responsible or liable for the accuracy or reliability of data associated with particular uses of any product described herein. Lunawood reserves the right to modify this document without prior notice.

Every facade is different, and this guide should not be considered to set out how a facade should be constructed in every circumstance. We accept no liability for any loss or injury caused by any reliance placed on this guide.

Lunawood reserves the right to update or revise the Terms and Conditions regarding installation guides in [www.lunawood.com](http://www.lunawood.com). The entire content of the Site is protected by copyright. You may not copy, distribute, or create derivative works from any part of this Web site (including its graphics, pictorial matter, and text) without the prior written consent of Oy Lunawood Ltd unless otherwise expressly permitted by the Site. Lunawood®; Lunawood TWPC and Lunawood Thermowood Plastic Composite and Profix are trademarks, service marks or trade names of Oy Lunawood Ltd and may not be used without prior written permission. Any links on this document or Lunawood.com to third party Web sites are not an endorsement, sponsorship, or recommendation of the third parties or the third parties' ideas, products, or services. Similarly, any references in this Site or document to third parties and their products or services do not constitute an endorsement, sponsorship, or recommendation. If you follow links to third party Web sites, including the Web sites of any other companies affiliated or unaffiliated with Lunawood, you are subject to the terms and conditions and privacy policies of those sites, and Lunawood makes no warranty or representations regarding those sites. Further, Lunawood is not responsible for the content of third party or affiliated company sites or any actions, inactions, results, or damages caused by visiting those sites.









